

## 2/2-way solenoid valve

stainless steel - 2/2-way type



Art. No. 102969

Type No. MV 100 ES

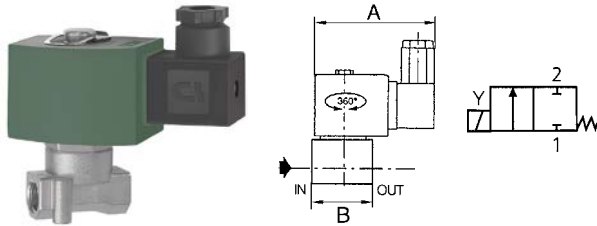

Exemplary illustration

### Available versions

- Directly operated
- Combined operation

### Technical data

Housing	Stainless steel 1.4301
Valve seat	stainless steel 1.4301
Internal parts	stainless steel
Protection IP	IP 65 (with connector socket fitted)
Type	1
Function	normally closed (NC)
Thread	NPT 1/8
DN	2,4 mm
Operating pressure	0 - 25 bar
Sealant	NBR
Electrical connection	for connector socket PG 11 P acc. to DIN 4400
Medium temperature	-25 to 80 °C
Ambient temperature	-25 to 55 °C
A	91 mm
B	30 mm

## Commercial data

Customs tariff number	84818073
Country of origin	DE
eCl@ss 5.1.4	27220601
eCl@ss 9.0	27220601
UNSPSC_Code_v190501	40141605
UNSPSC_CodeDesc_v190501	Solenoid valves

## Material informations

REACH SVHC1 substance name	lead
CAS no. SVHC 1	7439-92-1
RoHS materials notice	RoHS compliant
REACH Info	contains SVHC substance

# ASCO™ Solenoid Valves

For High Pressure Fluids | Direct Operated, 1/8" or 1/4" tapped | 15 mm Compression Fittings

Series  
262

## Features and Benefits

- High operating pressure
- RoHS compliance
- AC/DC interchangeability of the coil possible only for NC (10.1 W/1.6 W and 17.1 W/22.6 W)
- Valves do not require a minimum operating pressure
- Large selection of seal materials providing wide chemical compatibility
- Compliance with UL and CSA standards
- The solenoid valves satisfy all relevant EU directives

## General

**Differential pressure** See «SPECIFICATIONS» [1 bar = 100 kPa]  
**Maximum viscosity** 65 cSt (mm<sup>2</sup>/s)  
**Response time** 5 - 25 ms

Fluids (*)	Temperature range (TS)	Seal materials (*)
air, inert gas, water, oil	-25°C to +80°C	NBR (nitrile)
	0°C to +60°C	UR (cast urethane)

## Materials in contact with fluid

(\*) Ensure that the compatibility of the fluids in contact with the materials is verified

**Body** Brass or Stainless steel, AISI 304  
**Shading coil** Copper or Silver  
**Core tube** Stainless steel, AISI 305  
**Core and plugnut** Stainless steel, AISI 430F  
**Springs** Stainless steel, AISI 302  
**Seal** NBR  
**Disc** NBR or UR  
**Disc holder (NO function)** PA

## Electrical characteristics

**Coil insulation class** F (AC) or H (DC)  
**Connector** Spade plug (cable Ø 6-10 mm)  
**Connector specification** ISO 4400 / EN 175301-803, form A  
**Electrical safety** IEC 335  
**Electrical enclosure protection** Moulded IP65 (EN 60529)  
**Standard voltages** DC (=) : 24V - 48V  
 (Other voltages and 60 Hz on request) AC (~) : 24V - 48V - 115V - 230V/50 Hz

Operator ambient temperature range (TS) (°C)	Power ratings				Replacement coil <sup>(1)</sup>	
	Inrush ~ (VA)	Holding ~ (VA) (W)		Hot/cold = (W)	~	=
-25 to +55	30	16	8.1	7.7/ 10.6	238213-059	238513-006
	45	20	11.1	12.5/18.6	238213-157	238513-106
	50	25	10.1	8.5/11.6	238613-059	238913-006
	70	40	17.1	15.1/22.6	238613-159	238913-106

<sup>(1)</sup> All 238 basic numbers are UL & CSA approved and marked with the UR (recognised component) and CSA logos.

## Options

- Seals and disc (\*) <sup>(2)</sup>
  - FPM (fluoroelastomer): -15°C to +100°C (coil class F), -15°C to +120°C (coil class H)
  - EPDM (ethylene-propylene), 0°C to +100°C
  - CR (chloroprene), 0°C to +80°C
  - PTFE: -15°C to +100°C (coil class F), -15°C to +120°C (coil class H)
- Oxygen service, FPM disc and seals, see "PRODUCT CODE"
- WRAS approval, EPDM disc and seals, see "PRODUCT CODE"
- Magnetic latching versions, reverse polarity DC voltages, see "PRODUCT CODE FOR MAGNETIC LATCHING VERSION ONLY"
- 15 mm compression-fitting body, supplied with nut and olive, see "PRODUCT CODE"
- Connector with visual indication and peak voltage suppression or with cable length of 2 m
- Explosionproof enclosures for use in zones 1/21-2/22, categories 2-3 to ATEX Directive 2014/34/EU (See page: 4)

<sup>(2)</sup> The minimum ambient temperature of the solenoid valve is determined by the limitations of minimum temperature indicated.

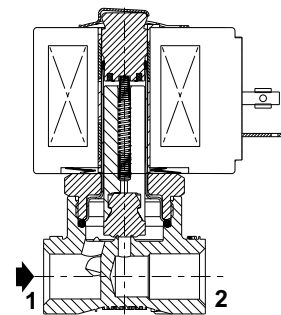

NC function

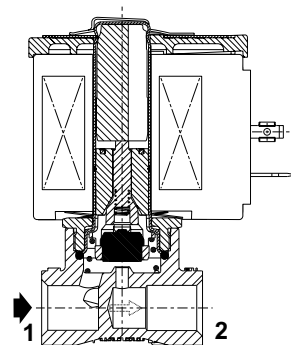

NO function

# ASCO™ Solenoid Valves

Series  
262

For High Pressure Fluids | Direct Operated, 1/8" or 1/4" tapped | 15 mm Compression Fittings

## Specifications

Specifications													PRODUCT CODE																											
Pipe size	Orifice size	Flow coefficient Kv		Operating pressure differential (bar)						Power coil (W)		Thread type	Dimensions / type <sup>(1)</sup>	Brass	Stainless steel	Voltage code																								
				Min.	Max. (PS)			~	=							~	=	~	=	24 V/50 Hz	48 V/50 Hz	115 V/50 Hz	230 V/50 Hz	24 V/DC	48 V/DC															
					Air (*)	Water (*)	Oil (*)																																	
(mm)	(m <sup>2</sup> /h)	(l/min)																																						
<b>Without manual operator</b>																																								
<b>NC - Normally closed, NBR seal and disc</b>																																								
1/8"	1.2	0.05	0.8	0	51	51	51	41	50	34	8.1	10.6	G NPT	01 01	G262K001S1N00	-																								
	2.4	0.18	3	0	25	14	22	10	13	10	8.1	10.6	G NPT	01 01	G262K014S1N00	-																								
	3.2	0.3	5	0	12	8	12	6.5	8	6	8.1	10.6	G NPT	01 01	G262K002S1N00	-																								
					18	10	17	8	13	8	11.1	18.6	G NPT	01 01	G262K016S1N00	-																								
1/4"	1.2	0.05	0.8	0	103	68	103	66	103	58	10.1	11.6	G* NPT	02 02	E262K200S1W00 <sup>(2)</sup>	-																								
					151	68	151	66	117	58	10.1	11.6	G* NPT	02 02	E262K214S1W00 <sup>(2)</sup>	-																								
					51	51	51	41	50	34	8.1	10.6	G* NPT	01 01	E262K019S1N00	-																								
	2.4	0.18	3	0	25	14	22	10	11	10	8.1	10.6	G* NPT	01 01	E262K020S1N00	-																								
					34	19	24	13	18	13	11.1	18.6	G* NPT	01 01	E262K021S1N00	-																								
					40	16	28	16	28	15	10.1	11.6	G* NPT	02 02	E262K108S1N00	E262K182S1N00																								
					49	41	28	28	28	27	17.1	22.6	G* NPT	02 02	E262K109S1N00	E262K183S1N00																								
	3.2	0.3	5	0	12	8	12	6.5	6	5.5	8.1	10.6	G* NPT	01 01	E262K022S1N00	-																								
					18	10	17	8	10	7.5	11.1	18.6	G* NPT	01 01	E262K023S1N00	-																								
					23	7.5	20	7	14	6.5	10.1	11.6	G* NPT	02 02	E262K232S1N00	E262K184S1N00																								
					34	17	26	17	24	15	17.1	22.6	G* NPT	02 02	E262K110S1N00	E262K185S1N00																								
					7	5	7	4	4	4	8.1	10.6	G NPT	01 01	E262K111S1N00	E262K186S1N00																								
14					3.5	13	3.5	10	3.5	10.1	11.6	G* NPT	02 02	E262K202S1N00	E262K220S1N00																									
5.6	0.63	10.5	0	6.5	2	6.5	2	6.5	2	10.1	11.6	G* NPT	02 02	E262K208S1N00	E262K226S1N00																									
				8.5	4	8.5	4	8.5	4	17.1	22.6	G* NPT	02 02	E262K114S1N00	E262K188S1N00																									
				3.5	2	3.5	2	2.5	1.9	8.1	10.6	G* NPT	01 01	E262K013S1N00	-																									
7.1	0.76	12.7	0	2	1.6	2	1.5	2	1.3	8.1	10.6	G* NPT	01 01	E262K090S1N00	-																									
				4	1.5	5	1.5	4	1.3	10.1	11.6	G* NPT	02 02	E262K210S1N00	E262K189S1N00																									
				6	3	6	3	6	3	17.1	22.6	G* NPT	02 02	E262K212S1N00	E262K230S1N00																									

<sup>(1)</sup> For dimensions, see drawing(s) for each construction type on the following page(s).  
 (\*) Ensure that compatibility of materials in contact with fluids is verified.

<sup>(2)</sup> UR disc only, fluid temperature 0°C to +60°C, no other elastomer can be used.

# ASCO™ Solenoid Valves

For High Pressure Fluids | Direct Operated, 1/8" or 1/4" tapped | 15 mm Compression Fittings

Series  
262

## Specifications

Pipe size	Orifice size	Flow coefficient Kv	Operating pressure differential (bar)										Power coil (W)	Thread type	Dimensions / type <sup>(1)</sup>	PRODUCT CODE		Voltage code							
			Max. (PS)													Brass	Stainless steel	24 V/50 Hz	48 V/50 Hz	115 V/50 Hz	230 V/50 Hz	24 V/DC	48 V/DC		
			Air (*)		Water (*)		Oil (*)		~	=	~	=												~	=
			~	=	~	=	~	=																	
<b>Without manual operator</b>																									
<b>NO - Normally open, NBR seal and disc</b>																									
1/8"	1.2	0.05	0.8	0	79	44	62	33	55	22	10.1	11.6	G* 02	E262K155S1W00 <sup>(2)</sup>	G262K168S1W00 <sup>(2)</sup>										
					NPT 02	-	8262K168S1W00 <sup>(2)</sup>																		
	2.4	0.18	3	0	18	11	15	9	12	6.5	10.1	11.6	G* 02	G262K156S1N00	G262K169S1N00										
					NPT 02	-	8262K169S1N00																		
	3.2	0.3	5	0	11	6.5	10	6.5	8.5	4.5	10.1	11.6	G* 02	G262K128S1N00	G262K236S1N00										
					NPT 02	-	8262K236S1N00																		
1/4"	1.2	0.05	0.8	0	79	44	62	33	55	22	10.1	11.6	G* 02	E262K161S1W00 <sup>(2)</sup>	E262K199S1W00 <sup>(2)</sup>										
					NPT 02	-	8262K199S1W00 <sup>(2)</sup>																		
	2.4	0.18	3	0	18	11	15	9	12	6.5	10.1	11.6	G* 02	E262K260S1N00	E262K130S1N00	FL	FR	FT	F8	H1	H9				
					NPT 02	-	8262K130S1N00																		
	3.2	0.3	5	0	11	6.5	10	6.5	8.5	4.5	10.1	11.6	G* 02	E262K261S1N00	E262K134S1N00										
					NPT 02	-	8262K134S1N00																		
4	0.47	7.8	0	6	4	6	3.5	4.5	3	10.1	11.6	G* 02	E262K262S1N00	E262K138S1N00											
				NPT 02	-	8262K138S1N00																			
5.6	0.72	12	0	3	2	3	1.7	2.5	1.7	10.1	11.6	G* 02	E262K263S1N00	E262K142S1N00											
				NPT 02	-	8262K142S1N00																			
7.1	0.83	13.8	0	2	1.3	2	1.1	2	1.1	10.1	11.6	G* 02	E262K264S1N00	E262K148S1N00											
				NPT 02	-	8262K148S1N00																			
<b>With maintained manual operator</b>																									
<b>NC - Normally closed, NBR seal and disc</b>																									
1/4"	2.4	0.18	3	0	40	16	28	16	28	15	10.1	11.6	G* 02	E262K108S1N01	E262K182S1N01										
					NPT 02	-	8262K182S1N01																		
	3.2	0.3	5	0	49	41	28	28	28	27	17.1	22.6	G* 02	E262K109S1N01	E262K183S1N01										
					NPT 02	-	8262K183S1N01																		
	4	0.45	7.5	0	23	7.5	20	7	14	6.5	10.1	11.6	G* 02	E262K232S1N01	E262K184S1N01										
					NPT 02	-	8262K184S1N01																		
	5.6	0.63	10.5	0	34	17	26	17	24	15	17.1	22.6	G* 02	E262K110S1N01	E262K185S1N01										
					NPT 02	-	8262K185S1N01																		
	7.1	0.76	12.7	0	14	3.5	13	3.5	10	3.5	10.1	11.6	G* 02	E262K202S1N01	E262K220S1N01	FL	FR	FT	F8	H1	H9				
					NPT 02	-	8262K220S1N01																		
	7.1	0.76	12.7	0	20	7.5	14	7.5	14	7.5	17.1	22.6	G* 02	E262K112S1N01	E262K187S1N01										
					NPT 02	-	8262K187S1N01																		
7.1	0.76	12.7	0	6.5	2	6.5	2	6.5	2	10.1	11.6	G* 02	E262K208S1N01	E262K226S1N01											
				NPT 02	-	8262K226S1N01																			
7.1	0.76	12.7	0	8.5	4	8.5	4	8.5	4	17.1	22.6	G* 02	E262K114S1N01	E262K188S1N01											
				NPT 02	-	8262K188S1N01																			
7.1	0.76	12.7	0	4	1.5	5	1.5	4	1.3	10.1	11.6	G* 02	E262K210S1N01	E262K189S1N01											
				NPT 02	-	8262K189S1N01																			
7.1	0.76	12.7	0	6	3	6	3	6	3	17.1	22.6	G* 02	E262K212S1N01	E262K230S1N01											
				NPT 02	-	8262K230S1N01																			

<sup>(1)</sup> For dimensions, see drawing(s) for each construction type on the following page(s).  
 (\*) Ensure that compatibility of materials in contact with fluids is verified.

<sup>(2)</sup> UR disc only, fluid temperature 0°C to +60°C, no other elastomer can be used.

# ASCO™ Solenoid Valves

For High Pressure Fluids | Direct Operated, 1/8" or 1/4" tapped | 15 mm Compression Fittings

Series  
262

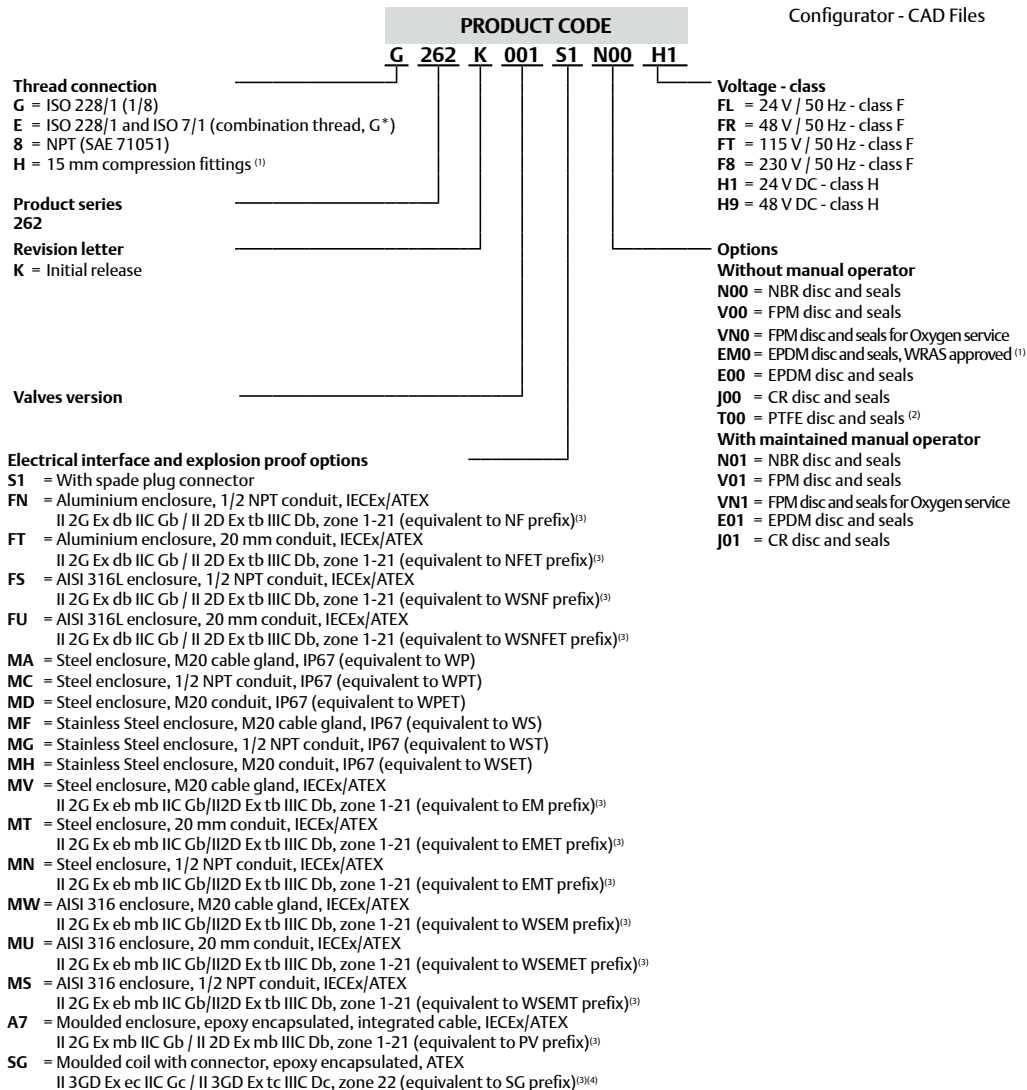

<sup>(1)</sup> Check the online configurator for available versions on Emerson.com/ASCO  
<sup>(2)</sup> Max. operating pressure limited to 75% of standard value.  
<sup>(3)</sup> Search prefix in Emerson.com/ASCO to get detailed technical information.  
 Please note that the valve pressure ratings with some of the ATEX enclosures will be reduced.  
 To obtain the correct pressure rating please check the landing pages of the "2-Way Solenoid Valve DIN Configurator".  
<sup>(4)</sup> Coils class F only.

# ASCO™ Solenoid Valves

Series  
262

For High Pressure Fluids | Direct Operated, 1/8" or 1/4" tapped | 15 mm Compression Fittings

		Spare parts kits no. (*)																
		AC (-)								DC (=)								
		NBR	FPM	FPM (oxygen)	EPDM	EPDM (+WRAS)	CR	PTFE	NBR + UR	NBR	FPM	FPM (oxygen)	EPDM	EPDM (+WRAS)	CR	PTFE	NBR + UR	
E262K013/019/020/021/022/023/090	M200001	N00	V00	VNO	E00	EMO	J00	T00	-	M200005	N00	V00	VNO	E00	EMO	J00	T00	-
E262K08/109/110/112/114	M200007	N00	V00	VNO	E00	EMO	J00	T00	-	M200007	N00	V00	VNO	E00	EMO	J00	T00	-
E262K130	M200017	N00	V00	VNO	E00	EMO	J00	T00	-	M200033	N00	V00	VNO	E00	EMO	J00	T00	-
E262K134	M200018	N00	V00	VNO	E00	EMO	J00	T00	-	M200033	N00	V00	VNO	E00	EMO	J00	T00	-
E262K138/142/148/152	M200018	N00	V00	VNO	E00	EMO	J00	T00	-	M200034	N00	V00	VNO	E00	EMO	J00	T00	-
E262K161	M200021	-	-	-	-	-	-	-	W00	-	-	-	-	-	-	-	-	-
E262K182/183/184/185/187/188/189	M200008	N00	V00	VNO	E00	EMO	J00	-	-	M200008	N00	V00	VNO	E00	EMO	J00	-	-
E262K200	M200007	-	-	-	-	-	-	-	W00	M200007	-	-	-	-	-	-	-	W00
E262K202/208/210/212	M200007	N00	V00	VNO	E00	EMO	J00	T00	-	M200007	N00	V00	VNO	E00	EMO	J00	T00	-
E262K214	M200008	-	-	-	-	-	-	-	W00	M200008	-	-	-	-	-	-	-	W00
E262K220/226/230	M200008	N00	V00	VNO	E00	EMO	J00	-	-	M200008	N00	V00	VNO	E00	EMO	J00	-	-
E262K232	M200007	N00	V00	VNO	E00	EMO	J00	T00	-	M200007	N00	V00	VNO	E00	EMO	J00	T00	-
E262K260	M200015	N00	V00	VNO	E00	EMO	J00	T00	-	M200031	N00	V00	VNO	E00	EMO	J00	T00	-
E262K261	M200016	N00	V00	VNO	E00	EMO	J00	T00	-	M200031	-	-	-	-	-	-	-	W00
E262K262/263/264/265	M200016	N00	V00	VNO	E00	EMO	J00	T00	-	M200032	N00	V00	VNO	E00	EMO	J00	T00	-
G262K001/002/014/016	M200001	N00	V00	VNO	E00	EMO	J00	T00	-	M200005	N00	V00	VNO	E00	EMO	J00	T00	-
G262K128	M200016	N00	V00	VNO	E00	EMO	J00	T00	-	M200031	N00	V00	VNO	E00	EMO	J00	T00	-
G262K129	M200016	N00	V00	VNO	E00	EMO	J00	T00	-	M200032	N00	V00	VNO	E00	EMO	J00	T00	-
G262K155	M200021	-	-	-	-	-	-	-	W00	-	-	-	-	-	-	-	-	-
G262K156	M200015	N00	V00	VNO	E00	EMO	J00	T00	-	M200031	N00	V00	VNO	E00	EMO	J00	T00	-
G262K168	M200021	-	-	-	-	-	-	-	W00	-	-	-	-	-	-	-	-	-
G262K169	M200017	N00	V00	VNO	E00	EMO	J00	T00	-	M200033	N00	V00	VNO	E00	EMO	J00	T00	-
G262K199	M200021	-	-	-	-	-	-	-	W00	-	-	-	-	-	-	-	-	-
G262K236	M200018	N00	V00	VNO	E00	EMO	J00	T00	-	M200033	N00	V00	VNO	E00	EMO	J00	T00	-
G262K237	M200018	N00	V00	VNO	E00	EMO	J00	T00	-	M200034	N00	V00	VNO	E00	EMO	J00	T00	-
8262K006/007/012/015/036/038	M200003	N00	V00	VNO	E00	EMO	J00	T00	-	M200005	N00	V00	VNO	E00	EMO	J00	T00	-
8262K080/086	M200003	N00	V00	VNO	E00	EMO	J00	T00	-	M200005	N00	V00	VNO	E00	EMO	J00	T00	-
8262K130	M200017	N00	V00	VNO	E00	EMO	J00	T00	-	M200033	N00	V00	VNO	E00	EMO	J00	T00	-
8262K134	M200018	N00	V00	VNO	E00	EMO	J00	T00	-	M200033	N00	V00	VNO	E00	EMO	J00	T00	-
8262K138/142/148/152	M200018	N00	V00	VNO	E00	EMO	J00	T00	-	M200034	N00	V00	VNO	E00	EMO	J00	T00	-
8262K168	M200021	-	-	-	-	-	-	-	W00	-	-	-	-	-	-	-	-	-
8262K169	M200017	N00	V00	VNO	E00	EMO	J00	T00	-	M200033	N00	V00	VNO	E00	EMO	J00	T00	-
8262K182/183/184/185/187/188/189	M200008	N00	V00	VNO	E00	EMO	J00	-	-	M200008	N00	V00	VNO	E00	EMO	J00	-	-
8262K199	M200021	-	-	-	-	-	-	-	W00	-	-	-	-	-	-	-	-	-
8262K220/226/230	M200008	N00	V00	VNO	E00	EMO	J00	-	-	M200008	N00	V00	VNO	E00	EMO	J00	-	-
8262K236	M200018	N00	V00	VNO	E00	EMO	J00	T00	-	M200033	N00	V00	VNO	E00	EMO	J00	T00	-
8262K237	M200018	N00	V00	VNO	E00	EMO	J00	T00	-	M200034	N00	V00	VNO	E00	EMO	J00	T00	-

(\*) Ensure that compatibility of materials in contact with fluids is verified.

# ASCO™ Solenoid Valves

For High Pressure Fluids | Direct Operated, 1/8" or 1/4" tapped | 15 mm Compression Fittings

Series  
262

## Magnetic latching version

Fluids (*)	Temperature range (TS)	Seal materials (*)
water	0°C to +85°C	EPDM

## Electrical characteristics

Coil insulation class F (DC)  
Standard voltages DC (=) : 3V - 6V - 9V - 12V

Operator ambient temperature range (TS) (°C)	Power ratings		Replacement coil <sup>(1)</sup>	
	Hot/cold =		=	
	(W)			
0 to +40	640	641/642/643/644	6 V DC	12 V DC
	2.5	-	400927-003	400927-005
	-	6	400927-007	400927-014

<sup>(1)</sup> All coils 400 series are not UL and CSA approved.





## Specifications

Pipe size	Orifice size (mm)	Flow coefficient Kv (m³/h)/(l/min)	Operating pressure differential (bar)		Power coil (W)	Thread type	Dimensions / type <sup>(2)</sup>	PRODUCT CODE							
			Min.	Max. (PS) Water (*)				Brass	Voltage code						
									3 V/DC	6 V/DC	9 V/DC	12 V/DC	24 V/DC		
<b>Without manual operator</b>															
15 mm compression fittings	1.2	0.05	0.8	0	10	2.5	H	03	H262K640S1EM0						
	2.0	0.15	2.5	0	10	6	H	03	H262K641S1EM0						
	3.2	0.30	5.0	0	3	6	H	03	H262K642S1EM0						
	4	0.45	7.5	0	2	6	H	03	H262K643S1EM0						
	6.7	0.82	13.7	0	0.7	6	H	03	H262K644S1EM0						

<sup>(2)</sup> For dimensions, see drawing(s) for each construction type on the following page(s).

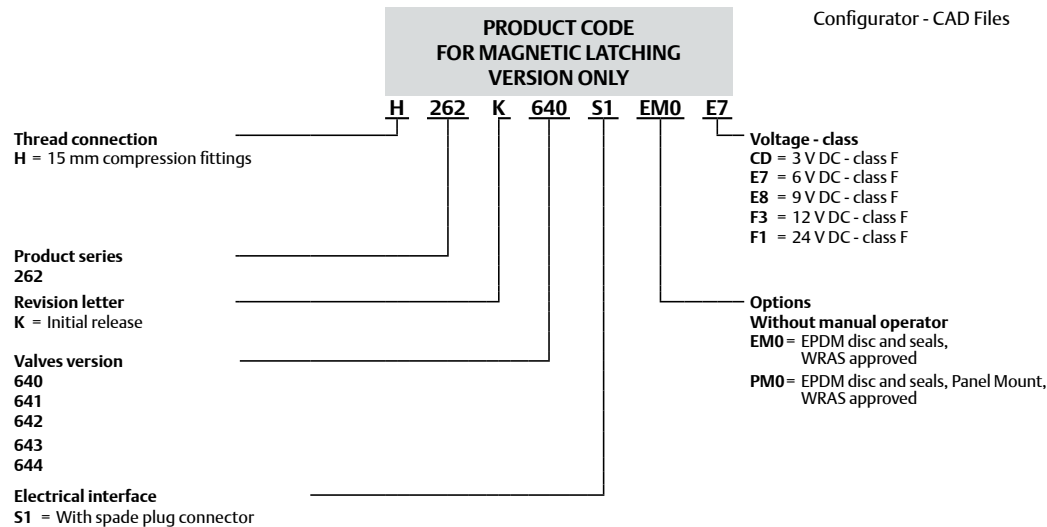
(\*) Ensure that compatibility of materials in contact with fluids is verified.



Spare parts kits no. (*)	
DC (=)	
EPDM (+ WRAS)	
 H262K640 / H262K641 H262K642 / H262K643 H262K644	<b>M200001</b> <b>EM0</b>

(\*) Ensure that compatibility of materials in contact with fluids is verified.

# ASCO™ Solenoid Valves

For High Pressure Fluids | Direct Operated, 1/8" or 1/4" tapped | 15 mm Compression Fittings

Series  
262

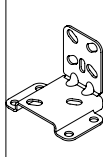
		Accessories code
	Mounting bracket Steel version (AISI 1010 / 1.1121)	M200094A00
	Mounting bracket Stainless steel version (AISI 304 / 1.4301)	M200095A00

## Installation

- The solenoid valves can be mounted in any position without affecting operation
- Solenoid valves have 2 mounting holes in body
- Thread connection "E" applicable for 1/4" have standard thread according to ISO 228/1 and ISO 7/1. Thread connection "G" applicable for 1/8", have standard thread according to ISO 228/1
- Thread connection "8" have standard thread = NPT (SAE 71051)
- Thread connection "H" have 1/2" male 'G' thread according to BS 2779 plus cap-nut and olive
- Installation/maintenance instructions are included with each valve

## Dimensions (mm), Weight (kg)

Configurator - CAD Files



**TYPE 01**  
Electrical interface "S1"  
Epoxy moulded  
IEC 335 / ISO 4400  
IP65

1/8", power coil 8.1 W / 10.6 W and 11.1 W / 18.6 W

1/4", power coil 8.1 W / 10.6 W and 11.1 W / 18.6 W

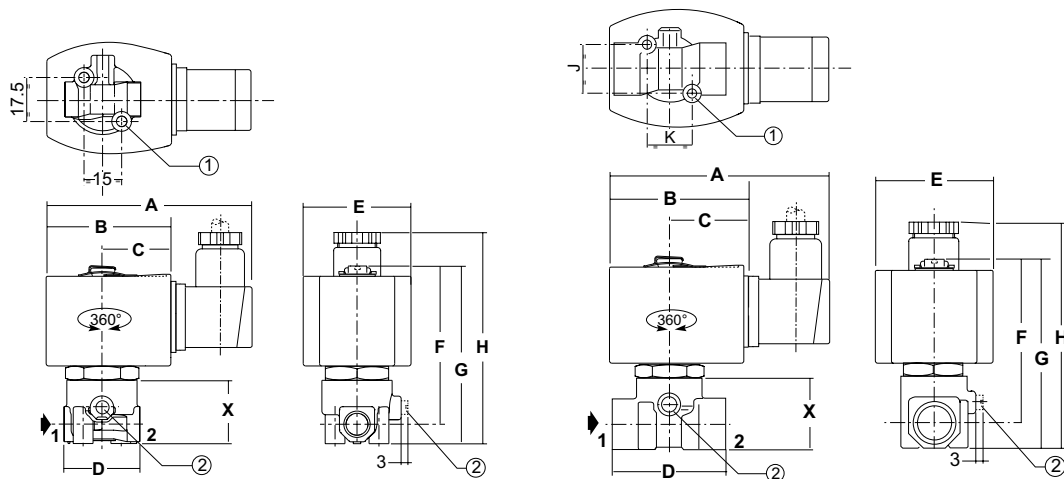

Type	Pipe size	A	B	C	D	E	F	G	H	X	Weight <sup>(1)</sup>
01	1/8"	88	51	30	30	43	62	71	88	26	0.30
	1/4"	88	51	30	40	43	65	75	92	30	0.42

- ① 2 mounting holes:  
M5 dia., depth 6.5 mm (1/8)  
M5 dia., depth 7.5 mm (1/4)
- ② Manual operator location

<sup>(1)</sup> Incl. coil(s) and connector(s).

# ASCO™ Solenoid Valves

For High Pressure Fluids | Direct Operated, 1/8" or 1/4" tapped | 15 mm Compression Fittings

Series  
262

Dimensions (mm), Weight (kg) 

Configurator - CAD Files



**TYPE 02**  
Electrical interface "S1"  
Epoxy moulded  
IEC 335 / ISO 4400  
IP65

NC: 1/4", power coil 10.1 W / 11.6 W and 17.1 W / 22.6 W

NO: 1/8"-1/4", power coil 10.1 W / 11.6 W

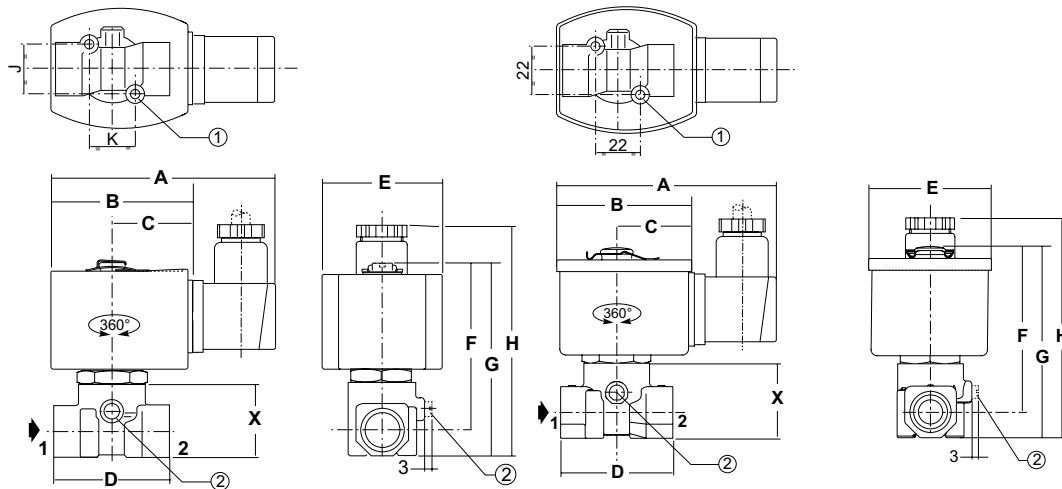

Type	Pipe size	A	B	C	D	E	F	G	H	J	K	X	Weight <sup>(1)</sup>
02	1/8" (NO)	96	59	34	30	52	67	75	88	17.5	15	26	0.50
	1/4" (NC)	95	57	33	40	50	69	78	96	22	22	30	0.60
	1/4" (NO)	96	59	34	40	52	69	78	96	22	22	30	0.62

<sup>(1)</sup> Incl. coil(s) and connector(s).

- ① 2 mounting holes:  
M5 dia., depth 7.5 mm  
(1/4")
- ② Manual operator location.

# ASCO™ Solenoid Valves

Series  
262

For High Pressure Fluids | Direct Operated, 1/8" or 1/4" tapped | 15 mm Compression Fittings

**Dimensions (mm), Weight (kg)**



**TYPE 03**  
Electrical interface "S1"  
Epoxy moulded  
IEC 335 / ISO 4400  
IP65

Magnetic latching coil 2.5 W / 6 W

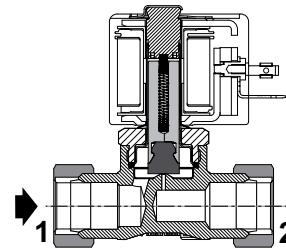
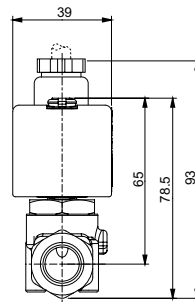
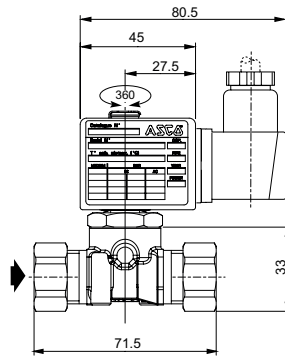
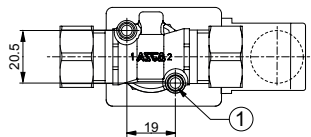

Magnetic Latching version

① 2 mounting holes:  
190-24 UNC-2B, depth 6 mm

Weight <sup>(1)</sup>
0.45

<sup>(1)</sup> Incl. coil(s) and connector(s).



**Mounting bracket**  
Steel or stainless steel

M200094A00 / M200095A00

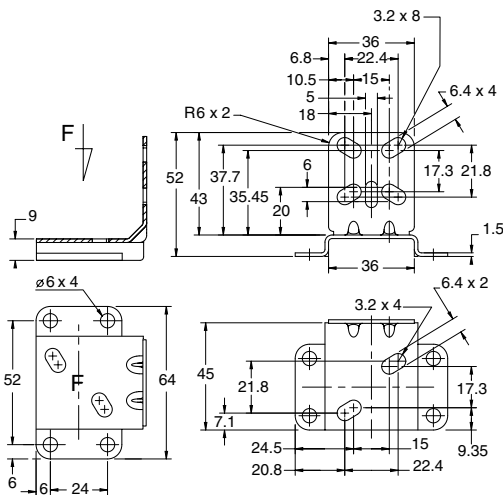

Availability, design and specifications are subject to change without notice.  
© 2023 Emerson Electric Co. All rights reserved.