



www.krause-systems.com



- DE** Das Programm für permanenten, professionellen Einsatz in Industrie und Handwerk.
- EN** The product range for permanent, professional use in industry and craft.
- PL** Program do stałego, profesjonalnego zastosowania w przemyśle i rzemiośle.
- RU** Программа для постоянного профессионального применения на производстве и строительно-монтажных работах
- HU** Termékcsalád rendszeres, professzionális használatra, szakem berek és ipari felhasználók számára.





SpeedMatic System



AutoSnap System



ClickMatic System



IntegratedTele System



SafetyCap



RollStop System



Doppel-KlappTritt Treppo

Double folding step • Schodki dwustronne składowe •
 Двусторонняя складная подставка • Összecsukható fellérb



				2 x 3	2 x 4	
1		A	ca.	m	2,65	2,85
		B	ca.	m	0,65	0,85
2		C	ca.	m	0,75	0,95
		D	ca.	m	0,65	0,85
			ca.	kg	4,8	6,2
	(B)	ca.	m	0,51	0,53	
	(T)	ca.	m	0,25	0,25	
	(L)	ca.	m	0,75	1,00	
Art.-No.				126030	126047	

ProfiTritt

Professional step • Schodki Profi •
Профессиональные подмости •
Profi fellérő

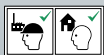
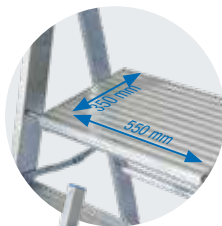

				3	4	
1		A	ca.	m	2,70	2,95
		B	ca.	m	0,70	0,95
2		C	ca.	m	1,35	1,60
		D	ca.	m	1,30	1,55
			ca.	kg	9,5	11,3
	B	ca.	m	0,7	0,7	
	T	ca.	m	0,23	0,23	
	L	ca.	m	1,40	1,65	
Art.-No.				126078	126085	

Stufen-Stehleiter

Step ladder • Drabiny ze stopniami wolnostojące • Стремянка со ступенями • Lépcsőfokos állólétra

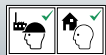

			4	5	6	7	8	10	12	
1		A bis ca.	m	2,95	3,20	3,40	3,65	3,90	4,35	4,80
		B ca.	m	0,95	1,20	1,40	1,65	1,90	2,35	2,80
2		C ca.	m	1,70	1,95	2,20	2,45	2,70	3,20	3,70
		D ca.	m	1,60	1,80	2,05	2,30	2,50	3,00	3,45
			kg	6,4	7,3	8,4	9,5	10,5	13	15,6
		B ca.	m	0,50	0,53	0,56	0,58	0,61	0,67	0,73
		T ca.	m	0,17	0,17	0,17	0,17	0,17	0,17	0,17
		L ca.	m	1,75	2,00	2,25	2,50	2,75	3,25	3,75
Art.-No.				124517	124524	124531	124548	124555	124562	124579

Stufen-Stehleiter, fahrbar

Mobile step ladder • Drabiny ze stopniami, wolnostojące z rolkami • Стремянка со ступенями, передвижная • Gurítható lépcsőfokos állólétra



			4	5	6	7	8	10	12	
1		A	ca. m	2,95	3,20	3,40	3,65	3,90	4,35	4,80
		B	ca. m	0,95	1,20	1,40	1,65	1,90	2,35	2,80
2		C	ca. m	1,70	1,95	2,20	2,45	2,70	3,20	3,70
		D	ca. m	1,60	1,80	2,05	2,30	2,50	3,00	3,45
			ca. kg	8,7	9,7	10,7	11,7	12,5	15,3	17,9
	B	ca. m	0,65	0,68	0,70	0,73	0,76	0,82	0,88	
	T	ca. m	0,17	0,17	0,17	0,17	0,17	0,17	0,17	
	L	ca. m	1,75	2,00	2,25	2,50	2,75	3,25	3,75	
Art.-No.			124616	124623	124630	124647	124654	124661	124678	

Stufen-Stehleiter, fahrbar mit Traverse

Mobile step ladder with stabiliser • Drabina wolnostojąca, jezdna ze stabilizatorem • Передвижная лестница-стремянка со ступенями, оснащенная траверсой • Gurítható lépcsőfokos állólétra, kitémasztóval



RollStop
System

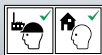

				6	7	8	10	12
1		A	ca. m	3,40	3,65	3,90	4,35	4,80
		B	ca. m	1,40	1,65	1,90	2,35	2,80
2		C	ca. m	2,20	2,45	2,70	3,20	3,70
		D	ca. m	2,05	2,30	2,50	3,00	3,45
			ca. m	0,84	0,84	0,97	1,10	1,10
			ca. kg	12,3	13,4	14,2	17,3	20,0
	B	ca. m	0,56	0,58	0,61	0,67	0,73	
	T	ca. m	0,17	0,17	0,17	0,17	0,17	
	L	ca. m	2,25	2,50	2,75	3,25	3,75	
Art.-No.				127303	127310	127327	127341	127365

Stufen-Stehleiter, große Plattform

Step ladder, extra large platform • Drabina wolnostojąca z dużą platformą • Стремянка со ступенями, передвижная • Lépcsőfokos állólétra nagy dobogóval

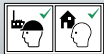
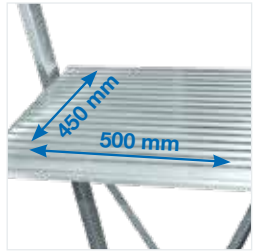

			4	6	7	8	9	10	12	14
1		A ca. m	2,95	3,40	3,65	3,90	4,10	4,35	4,80	5,30
		B ca. m	0,95	1,40	1,65	1,90	2,10	2,35	2,80	3,30
2		C ca. m	2,10	2,60	2,85	3,10	3,35	3,60	4,10	4,60
		D ca. m	1,95	2,40	2,65	2,90	3,10	3,35	3,80	4,30
		ca. m	0,88	0,88	0,88	0,97	0,97	1,10	1,10	1,25
		ca. kg	16,0	18,5	20,0	21,0	22,0	23,5	26,0	29,0
	B ca. m	0,58	0,58	0,58	0,58	0,58	0,58	0,58	0,58	0,58
	T ca. m	0,21	0,21	0,21	0,21	0,21	0,21	0,21	0,21	0,21
	L ca. m	2,10	2,60	2,85	3,10	3,35	3,60	4,10	4,60	
Art.-No.			127747	127761	127778	127785	127792	127808	127822	127846

Stufen-Stehleiter, mit großer Plattform und Sicherheitsbügel

Step ladder, with extra large platform and safety bar • Drabina wolnostojąca z dużą platformą i barierkami • Лестница-стремянка со ступенями, оборудованная большой платформой и дугой безопасности • Lépcsőfokos állólétra nagy dobogóval és biztonsági kerettel



				4	6	7	8	9	10	12	14
1		A	ca. m	2,95	3,40	3,65	3,90	4,10	4,35	4,80	5,30
		B	ca. m	0,95	1,40	1,65	1,90	2,10	2,35	2,80	3,30
2		C	ca. m	2,10	2,60	2,85	3,10	3,35	3,60	4,10	4,60
		D	ca. m	1,95	2,40	2,65	2,90	3,10	3,35	3,80	4,30
		ca. m	0,88	0,88	0,88	0,97	0,97	1,10	1,10	1,25	
		ca. kg	17,5	20,0	21,5	22,5	23,5	25,0	27,5	30,5	
	B	ca. m	0,58	0,58	0,58	0,58	0,58	0,58	0,58	0,58	
	T	ca. m	0,21	0,21	0,21	0,21	0,21	0,21	0,21	0,21	
	L	ca. m	2,25	2,75	3,00	3,25	3,50	3,75	4,25	4,75	
Art.-No.				127488	127501	127518	127525	127532	127549	127563	127587

Teleskop-Plattformleiter

Telescopic platform ladder • Drabina teleskopowa z platformą • Телескопическая лестница с площадкой • Teleszkópos létra dobogóval



			6	7	8	8	9	10		
1		A	ca.	m	3,55	3,80	4,10	4,10	4,35	4,60
		B	ca.	m	1,55	1,80	2,10	2,10	2,35	2,60
2		C	ca.	m	2,85	3,15	3,45	3,45	3,70	4,00
			ca.	m		0,80		0,90		
			ca.	kg		20,0		23,0		
	B	ca.	m		0,67		0,67			
	T	ca.	m		0,21		0,21			
	L	ca.	m		2,88		3,48			
Art.-No.					127624		127648			

Stufen-Doppelleiter mit Holzauflage

Double step ladder with wood top • Drabina dwustronna z drewnianą nakładką • Двухсторонняя лестница-стремянка со ступенями и деревянной накладкой • Két oldalon járható lépcsőfokos létra fa fedőlappal

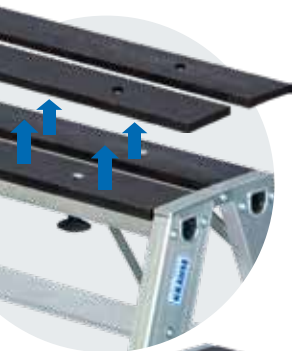

					2 x 4
1		A	ca.	m	2,45
		B	ca.	m	0,45
2		C	ca.	m	1,00
		D	ca.	m	0,95
3		A	ca.	m	2,95
		B	ca.	m	0,95
		C	ca.	m	1,00
		E	ca.	m	4,30
			ca.	kg	9,0
		B	ca.	m	0,79
		T	ca.	m	0,18
		L	ca.	m	1,05
Art.-No.					123862

Stufen-Doppelleiter

Double step ladder • Drabina dwustronna ze stopniami • Двухсторонняя лестница-стремянка со ступенями • Két oldalon járható lépcsőfokos létra

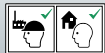

				2 x 3	2 x 4	2 x 5	2 x 6	2 x 7	2 x 8	2 x 10	2 x 12
1		A	ca. m	2,25	2,50	2,70	2,95	3,20	3,40	3,90	4,35
		B	ca. m	0,25	0,50	0,70	0,95	1,20	1,40	1,90	2,35
2		C	ca. m	0,80	1,05	1,30	1,55	1,80	2,05	2,55	3,05
		D	ca. m	0,70	0,95	1,20	1,40	1,65	1,90	2,35	2,80
			ca. kg	4,2	5,5	6,7	8,0	9,3	10,5	14,0	17,5
	B	ca. m	0,47	0,50	0,53	0,56	0,59	0,62	0,68	0,73	
	T	ca. m	0,18	0,18	0,18	0,18	0,18	0,18	0,18	0,18	
	L	ca. m	0,80	1,05	1,30	1,55	1,80	2,05	2,55	3,05	
Art.-No.				124715	124722	124739	124746	124753	124760	124777	124784

Stufen-Doppelleiter, fahrbar

Mobile double step ladder • Drabina dwustronna, jezdna • Передвижная двухсторонняя лестница
стремянка со ступенями • Két oldalon járható lépcsőfokos létra, gurítható



			2 x 3	2 x 4	2 x 5	2 x 6	2 x 7	2 x 8	2 x 10	2 x 12	
1		A	ca. m	2,25	2,50	2,70	2,95	3,20	3,40	3,90	4,35
		B	ca. m	0,25	0,50	0,70	0,95	1,20	1,40	1,90	2,35
2		C	ca. m	0,80	1,05	1,30	1,55	1,80	2,05	2,55	3,05
		D	ca. m	0,70	0,95	1,20	1,40	1,65	1,90	2,35	2,80
			ca. kg	6,5	7,7	9,0	10,3	11,6	12,9	16,3	19,4
	B	ca. m	0,61	0,64	0,67	0,70	0,73	0,76	0,82	0,86	
	T	ca. m	0,20	0,20	0,20	0,20	0,20	0,20	0,20	0,20	
	L	ca. m	0,80	1,05	1,30	1,55	1,80	2,05	2,55	3,05	
Art.-No.				124814	124821	124838	124845	124852	124869	124876	124883

Sprossen-Doppelleiter

Double rung ladder • Drabina dwustronna ze szczeblami • Двухсторонняя лестница-стремянка с перекладинами • Két oldalon járható állólétra



			2 x 6	2 x 7	2 x 8	2 x 10	2 x 12	2 x 14	2 x 16	2 x 18
1		A ca. m	3,05	3,30	3,55	4,10	4,60	5,10	5,75	6,25
		B ca. m	1,05	1,30	1,55	2,10	2,60	3,10	3,75	4,25
2		C ca. m	1,80	2,05	2,35	2,90	3,45	4,05	4,60	5,15
		D ca. m	1,65	1,95	2,20	2,70	3,25	3,75	4,40	4,95
		ca. kg	6,3	7,5	8,5	10,7	13,5	16,5	19,5	22,5
	B ca. m	0,57	0,59	0,63	0,69	0,70	0,82	0,85	0,91	
	T ca. m	0,14	0,14	0,14	0,14	0,14	0,14	0,15	0,15	
	L ca. m	1,80	2,10	2,40	2,95	3,50	4,05	4,60	5,15	
Art.-No.			124906	124913	124920	124937	124944	124951	801746	801753

Sprossen-Doppelleiter, Holz

Double rung ladder wood • Drabina dwustronna ze szczepkami • Двухсторонняя лестница-стремянка с перекладинами • Két oldalon járható fa állólétra



			2 x 4	2 x 5	2 x 6	2 x 7	2 x 8	2 x 9	2 x 10	2 x 12	
1		A	ca. m	2,50	2,75	3,00	3,25	3,50	3,80	4,05	4,55
		B	ca. m	0,50	0,75	1,00	1,25	1,50	1,80	2,05	2,55
2		C	ca. m	1,20	1,45	1,70	2,00	2,25	2,50	2,80	3,30
		D	ca. m	1,15	1,40	1,65	1,90	2,15	2,40	2,65	3,15
		ca.	kg	6,2	7,2	8,5	11,0	12,5	14,0	16,5	21,0
	B	ca.	m	0,48	0,51	0,54	0,57	0,60	0,63	0,66	0,73
	T	ca.	m	0,12	0,12	0,12	0,12	0,12	0,13	0,13	
	L	ca.	m	1,20	1,50	1,75	2,00	2,25	2,55	2,80	3,35
Art.-No.			170064	170071	170088	170095	170101	170118	170125	170149	

Stufen-Doppelleiter, Holz

Double step ladder wood • Drabina dwustronna ze stopniami • Двухсторонняя лестница-стремянка со ступенями • Két oldalon járható lépcsőfokos állólétra



			2 x 3	2 x 4	2 x 5	2 x 6	2 x 7	2 x 8	2 x 10	
1		A	ca. m	2,20	2,45	2,65	2,85	3,10	3,30	3,75
		B	ca. m	0,20	0,45	0,65	0,85	1,10	1,30	1,75
2		C	ca. m	0,70	0,95	1,15	1,40	1,65	1,85	2,35
		D	ca. m	0,65	0,85	1,10	1,30	1,55	1,75	2,20
			ca. kg	5,0	7,5	8,8	10,5	12,5	15,5	17,0
	B	ca. m	0,42	0,45	0,48	0,50	0,52	0,55	0,60	
	T	ca. m	0,20	0,20	0,20	0,20	0,20	0,20	0,20	
	L	ca. m	0,70	0,95	1,20	1,40	1,65	1,90	2,35	
Art.-No.				818201	818218	818225	818232	818249	818256	818270

Stufen-Anlegeleiter, einteilig

Leaning ladder with steps, one-piece • Drabina przystawna ze stopniami, jednoelementowa • Односекционная приставная лестница со ступенями • Lépcsőfokos támasztólétra, egyrészes

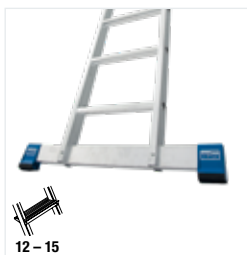

12 – 15



				6	7	8	10	12	15
1		A	ca. m	2,70	2,90	3,15	3,60	4,10	4,80
		B	ca. m	0,70	0,90	1,15	1,60	2,10	2,80
2		C	ca. m	1,70	1,95	2,20	2,70	3,20	3,95
		D	ca. m	1,60	1,80	2,05	2,50	3,00	3,70
			ca. m	–	–	–	–	0,79	0,79
			ca. kg	3,6	4,2	4,8	6,0	7,2	9,0
	B	ca. m	0,38	0,38	0,38	0,38	0,38	0,38	0,38
	T	ca. m	0,10	0,10	0,10	0,10	0,10	0,10	0,10
	L	ca. m	1,70	1,95	2,20	2,70	3,20	3,95	
Art.-No.				124401	124418	124425	124432	134707	134745

Sprossen-Anlegeleiter, einteilig

Leaning ladder with rungs, one-piece • Drabina przystawna ze szczeblami, jednoelementowa • Односекционная приставная лестница с перекладинами • Létrafokos támasztólétra, egyrészes



			6	9	12	15	18	20	22	24		
1		A	ca.	m	2,80	3,60	4,40	5,25	6,05	6,60	7,10	7,65
		B	ca.	m	0,80	1,60	2,40	3,25	4,05	4,60	5,10	5,65
2		C	ca.	m	1,85	2,70	3,55	4,35	5,20	5,75	6,35	6,90
		D	ca.	m	1,80	2,60	3,40	4,25	5,05	5,60	6,10	6,65
			ca.	m	–	–	0,79	0,87	0,97	1,12	1,12	1,12
			ca.	kg	3,7	5,2	6,7	8,3	9,9	11,3	12,7	14,0
	B	ca.	m	0,43	0,43	0,43	0,43	0,43	0,43	0,43	0,43	0,43
	T	ca.	m	0,07	0,07	0,07	0,07	0,07	0,08	0,08	0,08	0,08
	L	ca.	m	1,90	2,70	3,55	4,40	5,25	5,80	6,35	6,90	
Art.-No.			127013	127037	133106	133120	133151	133175	133182	133199		

Sprossen-Schiebeleiter, zweiteilig

Extension ladder with rungs, two-piece • Drabina rozsuwana ze szczeblami, dwuelementowa • Двухсекционная раздвижная лестница с перекладинами • Létrafokos tolólétra, kétrészes



				2 x 9	2 x 12	2 x 15	2 x 18
1 +		A	ca. m	5,25	6,85	8,45	9,85
		B	ca. m	3,25	4,85	6,45	7,85
		C	ca. m	4,35	6,05	7,75	9,15
		D	ca. m	4,20	5,85	7,45	8,80
2 +		A	ca. m	3,60	4,40	5,25	6,05
		B	ca. m	1,60	2,40	3,25	4,05
		C	ca. m	2,70	3,55	4,35	5,20
		D	ca. m	2,60	3,40	4,25	5,05
			ca. m	0,87	0,97	1,12	1,25
			ca. kg	9,8	15,0	19,6	27,2
	B	ca. m	0,43	0,43	0,43	0,43	
	T	ca. m	0,12	0,14	0,14	0,18	
	L	ca. m	2,70	3,55	4,40	5,25	
Art.-No.				133274	133304	133328	133359

Sprossen-Seilzugleiter, zweiteilig

Rope-operated two-piece extension ladder with rungs • Drabina rozsuwana linką, ze szczeblami, dwuelementowa • Двухсекционная лестница с перекладинами, выдвигаемая тросом • Létrafokos húzóköteles létra, kétrészes

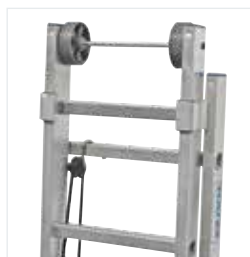

				2 x 15	2 x 18	2 x 20	2 x 24
1		A	ca. m	8,45	9,85	10,95	13,10
		B	ca. m	6,45	7,85	8,95	11,10
		C	ca. m	7,70	9,10	10,30	12,50
		D	ca. m	7,45	8,80	9,95	12,10
2		A	ca. m	5,25	6,05	6,60	7,70
		B	ca. m	3,25	4,05	4,60	5,70
		C	ca. m	4,35	5,20	5,80	6,90
		D	ca. m	4,20	5,00	5,60	6,70
			ca. m	1,12	1,25	1,35	1,35
			ca. kg	21,0	28,1	33,0	39,5
	B	ca. m	0,38	0,38	0,42	0,42	
	T	ca. m	0,14	0,18	0,20	0,20	
	L	ca. m	4,40	5,20	5,80	6,95	
Art.-No.				133847	133878	800718	800725

Sprossen-Seilzugleiter, dreiteilig

Rope-operated three-piece extension ladder with rungs • Drabina rozsuwana linką, ze szczeblami, trzejelementowa • Трехсекционная лестница с перекладинами, выдвигаемая тросом • Létrafokos húzóköteles létra, háromrészes



				3 x 14	3 x 16	3 x 18
1		A	ca. m	9,75	11,35	12,95
		B	ca. m	7,75	9,35	10,95
		C	ca. m	9,05	10,75	12,45
		D	ca. m	8,75	10,40	12,00
2		A	ca. m	4,85	5,40	5,95
		B	ca. m	2,85	3,40	3,95
		C	ca. m	4,10	4,90	5,30
		D	ca. m	3,90	4,45	4,95
		ca. m		1,20	1,20	1,20
		ca. kg		45,0	51,0	56,6
	B	ca. m		0,48	0,48	0,48
	T	ca. m		0,25	0,25	0,25
	L	ca. m		4,10	4,90	5,30
Art.-No.				800756	800763	800770

Sprossen-Mehrzweckleiter

Multipurpose ladder with rungs • Drabina rozstawno-przystawna • Универсальная лестница с перекладинами • Létrafokos többcéltű létra



				2 x 9	2 x 12		
1		A	ca.	m	5,25	6,85	
		B	ca.	m	3,25	4,85	
		C	ca.	m	4,35	6,05	
		D	ca.	m	4,20	5,85	
2		A	ca.	m	3,85	4,65	
		B	ca.	m	1,85	2,65	
		C	ca.	m	2,70	3,50	
		D	ca.	m	2,55	3,35	
3		A	ca.	m	3,60	4,45	
		B	ca.	m	1,60	2,45	
		C	ca.	m	2,70	3,50	
		D	ca.	m	2,60	3,40	
				ca.	m	0,87	0,97
				ca.	kg	10,1	14,5
	B	ca.	m	0,43	0,43		
	T	ca.	m	0,12	0,14		
	L	ca.	m	2,70	3,55		
Art.-No.				133472	133502		

STABILO®

Professional



Sprossen-VielzweckLeiter

Multipurpose ladder with rungs, three-piece • Drabina wielofunkcyjna • Многоцелевая лестница с перекладинами • Létrafokos sokcélú létra

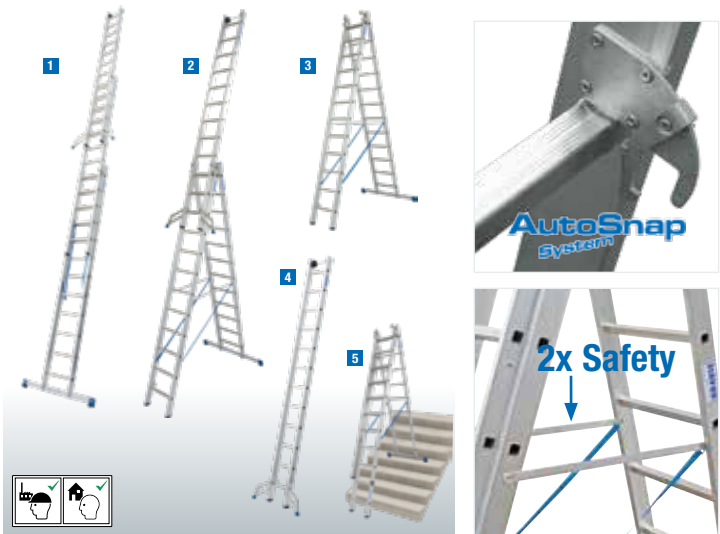

		3 x 8	3 x 9	3 x 10	3 x 12	3 x 14	
1		A ca. m	6,05	6,85	7,65	9,30	10,90
	B ca. m	4,05	4,85	5,65	7,30	8,90	
	C ca. m	5,25	6,05	6,90	8,60	10,25	
	D ca. m	5,05	5,85	6,65	8,30	9,90	
2		A ca. m	4,40	4,95	5,45	6,55	7,60
	B ca. m	2,40	2,95	3,45	4,55	5,60	
	C ca. m	3,80	4,40	4,95	6,05	7,20	
	D ca. m	3,65	4,20	4,70	5,80	6,85	
3		A ca. m	3,60	3,85	4,10	4,65	5,20
	B ca. m	1,60	1,85	2,10	2,65	3,20	
	C ca. m	2,40	2,70	3,00	3,55	4,10	
	D ca. m	2,30	2,55	2,80	3,35	3,90	
4		A ca. m	3,35	3,60	3,90	4,40	4,95
	B ca. m	1,35	1,60	1,90	2,40	2,95	
	C ca. m	2,40	2,70	3,00	3,55	4,10	
	D ca. m	2,35	2,60	2,85	3,40	3,95	
5		A ca. m	4,40	4,65	4,95	–	–
	B ca. m	2,40	2,65	2,95	–	–	
	C ca. m	3,25	3,55	3,80	–	–	
	D ca. m	3,10	3,40	3,65	–	–	
	ca. m	0,97	0,97	1,25	1,25	1,40	
	ca. kg	16,0	17,0	18,5	28,1	31,6	
	B ca. m	0,50	0,50	0,50	0,50	0,50	
	T ca. m	0,20	0,20	0,20	0,24	0,24	
	L ca. m	2,45	2,70	3,00	3,55	4,10	

Art.-No. 133748 133755 133762 133700 133724

Combi Extras

34

Sprossen-Gelenk-Doppelleiter

Hinged double rung ladder • Dwustronna drabina przegubowa •
Шарнирная двухсекционная лестница с перекладинами • Csuklós állólétra



				2 x 6	2 x 8	
1		A	ca.	m	4,40	5,50
		B	ca.	m	2,40	3,50
		C	ca.	m	3,55	4,65
		D	ca.	m	3,40	4,50
2		A	ca.	m	3,05	3,55
		B	ca.	m	1,05	1,55
		C	ca.	m	1,80	2,35
		D	ca.	m	1,70	2,25
			ca.	m	0,79	0,87
			ca.	kg	8,5	10,6
	B	ca.	m	0,37	0,37	
	T	ca.	m	0,14	0,14	
	L	ca.	m	1,80	2,35	
Art.-No.				133908	133915	

Sprossen-Gelenk-Universalleiter

Hinged universal rung ladder • Uniwersalna drabina przegubowa • Шарнирная универсальная лестница • Univerzális csuklós létra



SpeedMatic
System



SafetyCap



Combi ⑦
System

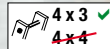

				4 x 3	4 x 4	
1		A	ca.	m	4,40	5,50
		B	ca.	m	2,40	3,50
		C	ca.	m	3,55	4,70
		D	ca.	m	3,45	4,50
2		A	ca.	m	3,05	3,55
		B	ca.	m	1,05	1,55
		C	ca.	m	1,80	2,35
		D	ca.	m	1,75	2,25
3		A	ca.	m	2,95	–
		B	ca.	m	0,95	–
		C	ca.	m	0,95	–
		D	ca.	m	0,95	–
		ca.	kg	12,5	14,5	
	B	ca.	m	0,37	0,37	
	T	ca.	m	0,28	0,28	
	L	ca.	m	1,00	1,30	
Art.-No.				123510	123503	

Combi Extras

34

Sprossen-Gelenk-Teleskopleiter

Hinged telescopic rung ladder • Przegubowa drabina teleskopowa • Шарнирная телескопическая лестница с перекладинами • Teleszkópos csuklós létra



				4 x 4	4 x 5
1		A	ca. m	5,00	6,05
		B	ca. m	3,00	4,05
		C	ca. m	4,25	5,35
		D	ca. m	4,10	5,20
2		A	ca. m	3,35	3,90
		B	ca. m	1,35	1,90
		C	ca. m	2,15	2,70
		D	ca. m	2,05	2,60
3		A	ca. m	3,00	3,00
		B	ca. m	1,00	1,00
		C	ca. m	1,30	1,60
		D	ca. m	1,25	1,50
			ca. kg	15,5	18,0
	B	ca. m	0,68	0,68	
	T	ca. m	0,21	0,21	
	L	ca. m	1,35	1,60	
Art.-No.				133953	133960

Sprossen-Gelenk-Teleskopleiter mit 4 Holmverlängerungen

Hinged telescopic rung ladder with 4 rail extensions • Przegubowa drabina teleskopowa z 4 regulowanymi nogami • Шарнирная телескопическая лестница с перекладинами и 4 удлинителями боковин • Teleszkópos csuklós létra 4 szárhosszabbítóval

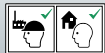

				4 x 4	4 x 5
1		A	ca. m	5,00	6,05
		B	ca. m	3,00	4,05
		C	ca. m	4,20	5,35
		D	ca. m	4,10	5,15
2		A	ca. m	3,35	3,90
		B	ca. m	1,35	1,90
		C	ca. m	2,15	2,70
		D	ca. m	2,05	2,55
3		A	ca. m	3,00	3,00
		B	ca. m	1,00	1,00
		C	ca. m	1,30	1,60
		D	ca. m	1,25	1,50
			ca. kg	16,0	18,5
	B	ca. m	0,67	0,67	
	T	ca. m	0,21	0,21	
	L	ca. m	1,35	1,60	
Art.-No.				133977	133984

STABILO[®]
Professional

SpeedMatic



Sprossen-Gelenk-CombiLeiter

Hinged combination rung ladder • Przegubowa drabina teleskopowa • Шарнирная телескопическая лестница с перекладинами • Kombinált csuklós létra



				2 x 3 + 2 x 6	
1		A	ca.	m	5,30
		B	ca.	m	3,30
		C	ca.	m	4,70
		D	ca.	m	4,70
1		A	ca.	m	4,20
		B	ca.	m	2,20
		C	ca.	m	3,55
		D	ca.	m	3,55
1		A	ca.	m	3,35
		B	ca.	m	1,35
		C	ca.	m	1,85
		D	ca.	m	1,85
2		A	ca.	m	4,20
		B	ca.	m	2,20
		C	ca.	m	3,00
		D	ca.	m	3,00
2		A	ca.	m	3,05
		B	ca.	m	1,05
		C	ca.	m	1,80
		D	ca.	m	3,00
2		A	ca.	m	2,25
		B	ca.	m	0,25
		C	ca.	m	0,95
		D	ca.	m	0,95
3		A	ca.	m	4,20
		B	ca.	m	2,20
		C	ca.	m	2,90
		D	ca.	m	2,90
4		A	ca.	m	2,80
		B	ca.	m	0,80
		C	ca.	m	-
		D	ca.	m	-
			ca.	m	0,87
			ca.	kg	14,6
		B	ca.	m	0,42
		T	ca.	m	0,19
		L	ca.	m	1,90
Art.-No.				133922	
				Combi Extras	

Technische Schutzmaßnahmen als Nachrüstung für ihren Altbestand

Technical safety measure as retrofitting for your old stock

Dodatkové wyposażenie ochronne do starych wersji

Инженерно-технические мероприятия для модернизации для Вашего старого фонда

Műszaki óvintézkedés régi készletei kiegészítésének

Universal-Traverse

Stabiliser, universally usable • Alsó kitámasztók, általános felhasználásra • Траверса универсального использования
• Kombinált csuklós létra



Art.-No.		
STABILO (64 mm)		
213600	875 mm	315 – 435 mm
213617	970 mm	360 – 480 mm
213624	1250 mm	360 – 480 mm

STABILO® Trigon Traversen-Set

Professional

Trigon stabiliser set • Komplet stabilizatorów TRIGON • Набор траверс Trigon • Trigon traversz szett

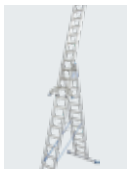

Art.-No.	
202239	12-14
202246	15-18

Niveau-Traverse

Level stabiliser • Stabilizator wyrównujący poziom • Траверса - уровень • Szintkiegyenlítő traverz



Art.-No.		
213761	875 mm	315 – 435 mm
213778	970 mm	360 - 480 mm
213785	1.250 mm	360 – 480 mm

Nut-Traverse

Tongue stabiliser • Stabilizator wpustowy • Траверса с тунельной регулировкой • Kiegészítő kitámasztó



Art.-No.	
212252	1.000 mm
212269	1.250 mm

Entnahmebegrenzung

Removal locking device • Blokada wyjęcia • Лимит снятия • Kiemelésgátló



Art.-No.
202284

Combi Extras System®



1

Art.-No.122063

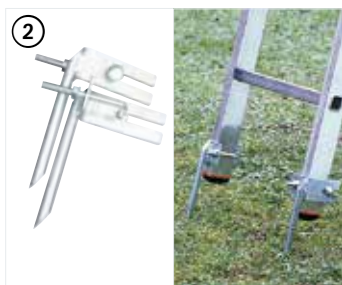

2

Art.-No.121400



3

Art.-No.122292



4

Art.-No.122018

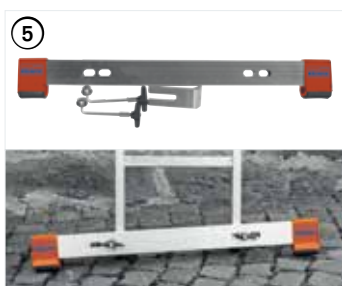

5

Art.-No.121417



6

Art.-No.122285



7

4 x 3 ✓
~~**4 x 4**~~

Art.-No.122261 (810 mm)

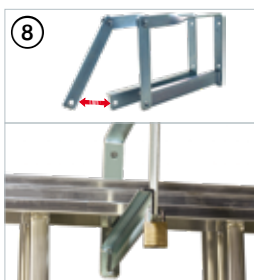

8

Art.-No.122469 (2x)



9

Art.-No.122308 (2x)

TeleBoard® Alu-Teleskop-Bohle

System®

Telescopic aluminium platform • Rozsuwana platforma robocza •
Телескопический алюминиевый помост • Teleszkópos alumínium palló



EXTRAS

BoardStand



2

(2 x)

Art.-No.

123732



4,0 kg



TeleSet

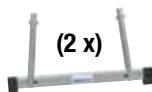

3

(2 x)

Art.-No.

123749



2,0 kg

1 TeleBoard	Art.-No.	123701	123718
	(ca.)	12,0 kg	13,5 kg
	(ca.)	1,75 m	2,05 m
	(ca.)	2,98 m	3,50 m
	A (ca.)	2,50 m	
	B (ca.)	0,50 m	
	A (ca.)	min.	2,60 m
	A (ca.)	max.	2,80 m
	B (ca.)	min.	0,60 m
	B (ca.)	max.	0,80 m

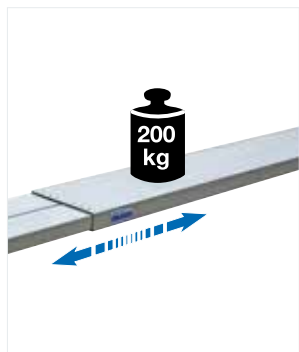











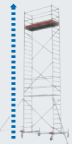

STABILO®
Professional

FahrGerüst-System

Mobile scaffold system • Rusztowania jezdne •
Система передвижных вышек • utulóállvány-rendszer



Serie Series Seria Sorozat серия						
STABILO FaltGerüst		2,00 m	0,60 m	3,00 m	Ø 150 mm	–
STABILO 10		2,00 m	0,75 m	14,40 m	Ø 150 mm	–
		2,50 m				
STABILO 50		2,00 m	1,50 m	14,40 m	Ø 150 mm	–
		2,50 m				
STABILO 100		2,00 m	0,75 m	12,00 m	Ø 200 mm	–
		2,50 m		14,40 m		
		3,00 m				
STABILO 500		2,00 m	1,50 m	12,40 m	Ø 200 mm	–
		2,50 m		14,40 m		
		3,00 m				
STABILO 1000		2,00 m	0,75 m	12,30 m	Ø 200 mm	4
		2,50 m		14,30 m		
		3,00 m				
STABILO 5000		2,00 m	1,50 m	12,30 m	Ø 200 mm	4
		2,50 m		14,30 m		
		3,00 m				
STABILO 5500		2,00 m	1,50 m	12,00 m	Ø 200 mm	4



Sonderlösung mit System

- Custom-made solutions with system
- Konstrukcje specjalne
- Специальные системные решения
- Egyedi szerkezetek rendszere

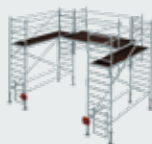



KRAUSE-Werk GmbH & Co. KG
Am Kreuzweg 3
D-36304 Alsfeld
Tel.: +49 (0) 66 31 / 7 95-0
Fax: +49 (0) 66 31 / 7 95-139
E-Mail: info@krause-systems.de



KRAUSE-Systems AG
Chrümble 9
CH-5623 Boswil
Tel.: +41 (0)56 666 90 50
Fax: +41 (0)56 666 90 51
E-Mail: info@krause-systems.ch



KRAUSE Sp. z o. o.
ul. Stalowa 10
PL - 58- 100 Świdnica
Tel.: +48 74 / 851-88-00
Fax: +48 74 / 851-88-22
E-Mail: info@krause-systems.pl



KRAUSE Kft.
H-2030 Érd
Tolmács u. 7.
Tel.: +36 (06) 23 / 521 130
Fax: +36 (06) 23 / 365 109
E-Mail: info@krause-systems.hu



ООО КРАУЗЕ-СИСТЕМС
RU-129090 Москва
ул. Гиляровского 4, стр. 5, офис 204
тел.: +7 (495) 640 46 56
факс: +7 (495) 640 46 56
E-Mail: info@krause-systems.ru



ТОО „КРАУЗЕ-СИСТЕМС“
KZ-010000, г. Нур-Султан
шоссе Коргалжын 19,
БЦ „Korgalzhyn“, офис 305 Б
Тел +7 (7172) 57 67 98
E-Mail: info@krause-systems.com.kz

Besuchen Sie uns im Internet:
Visit our website:
www.krause-systems.com

